

# Trojan 5 & 6

## Description

The Trojan family is a universal tongue-operated (or key-operated) safety-interlock switch designed to fit at the leading edge of sliding, hinged or lift-off guards. The dual key entry slots and rotatable head, movable only by releasing the cover screws, allow four actuator entry options. The Trojan contains all of the safety related functions—i.e., forced guided contacts, tamper resistant mechanism—allowing the machine to be safeguarded in compliance with the machine directive.

Operation of the switch is achieved through the insertion of a specially-profiled stainless-steel key that is permanently mounted to the leading edge of the guard door. The standard (not GD2) Trojan actuator includes a self-ejecting mechanism that prevents operation of the switch if the actuator is not mounted to the guard door (e.g., if the operator uses a spare key).

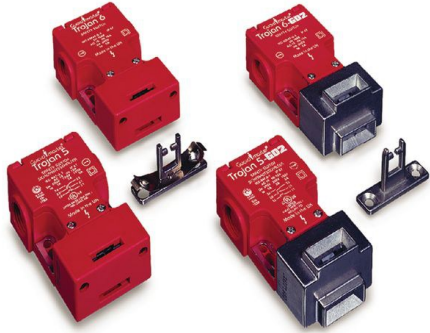

## Features

- Strong and versatile, can be used in most applications
- Self-ejecting tamper resistant actuator, only operates when mounted to the guard (not with GD2 models)
- Four possible actuator entry points, easy to install
- GD2 style available for demanding applications

## Specifications

Safety Ratings					
Standards	EN 954-1, ISO 13849-1, IEC/EN 60204-1, NFPA 79, EN 1088, ISO 14119, IEC/EN 60947-5-1, ANSI B11.19, AS 4024.1				
Safety Classification	Cat. 1 device per EN 954-1 dual channel interlocks suitable for Cat. 3 or 4 systems				
Functional Safety Data * Note: For up-to-date information, visit <a href="http://www.ab.com/Safety/">http://www.ab.com/Safety/</a>	B10d: > 2 x 10 <sup>6</sup> operations at min. load PFH <sub>D</sub> : > 3 x10 <sup>-7</sup> MTTFd: > 385 years Dual channel interlock may be suitable for performance levels Ple or Pld (according to ISO 13849-1:2006) and for use in SIL2 or SIL3 systems (according to IEC 62061) depending on application characteristics				
Certifications	CE Marked for all applicable directives, cULus, TÜV, and CCC				
Outputs					
Safety Contacts ‡ Direct Opening Action	3 N.C.	2 N.C.	2 N.C.		
Auxiliary Contacts	1 N.O.	2 N.O.	1 N.O.		
Thermal Current I <sub>th</sub>	10 A				
Rated Insulation Voltage	(Ui) 500V				
Switching Current @ Voltage, Min.	3 mA @ 18V DC				
Utilization Category					
Trojan 5 A300/AC-15	(Ue)	240V	120V		
	(Ie)	3 A	6 A		
DC-13	(Ue)	24V	24V		
	(Ie)	2 A			
Trojan 6 A600/AC-15	(Ue)	600V	500V	240V	120V
	(Ie)	1.2 A	1.4 A	3 A	6 A
DC-13	(Ue)	24V			
	(Ie)	2 A			
Operating Characteristics					
Break Contact Force, Min.	Trojan 5: 12 N (2.7 lbf) & 30 N (6.75 lbf)				
	Trojan 6: 20 N (4.5 lbf)				
Actuation Speed, Max.	160 mm (6.29 in.)/s				
Actuation Frequency, Max.	2 cycles/s				
Operating Radius, Min	175 mm (6.89 in.) [60 mm (2.36 in.) with flexible actuator]				
Mechanical Life	1,000,000 operations				
Environmental					
Enclosure Type Rating	IP67				
Operating Temperature [C (F)]	-20...+80° (-4...+176°)				
Physical Characteristics					
Housing Material	UL Approved glass-filled PBT				
Actuator Material	Stainless Steel				
Weight [g (lb)]	160 (0.35)				
Color	Red				

\* Usable for ISO 13849-1:2006 and IEC 62061. Data other than B10d is based on:

- Usage rate of 1op/10 mins., 24 hrs/day, 360 days/year, representing 51840 operations per year
- Mission time/Proof test interval of 38 years

‡ The safety contacts are described as normally closed (N.C.) i.e., with the guard closed, actuator in place (where relevant) and the machine able to be started.

## Product Selection

Type	Contact			Actuator Type	Cat. No.						
					M20 Conduit		Connector♣				
	Safety	Auxiliary	Action		M20	1/2 inch NPT Adaptor	Connect to Distribution Box 6-Pin Micro (M12)	Connect to ArmorBlock Guard I/O 5-Pin Micro (M12)Δ			
Trojan 5 Standard	2 N.C.	1 N.O.	BBM	Standard	440K-T11090	440K-T11202	440K-T11205	—			
				Guide/semi-flexible	440K-T11110	440K-T11203	440K-T11206	—			
				Guide/fully flexible	440K-T11467	440K-T11204	440K-T11207	440K-T2NNBPS			
				—	440K-T11089	—	440K-T11129	—			
			BBM Gold Contacts	Standard	440K-T11085	—	—	—			
			MBB	Standard	440K-T11118	440K-T11208	440K-T11224	—			
				Guide/semi-flexible	440K-T11123	440K-T11209	440K-T11363	—			
				Guide/fully flexible	440K-T11468	440K-T11210	440K-T11364	—			
				—	440K-T11146	440K-T11469	440K-T11365	—			
			Trojan 5 GD2			BBM	GD2 standard	440K-T11336	440K-T11211	440K-T11366	440K-T2NNGPS-NG
Guide/semi-flexible	440K-T11337	440K-T11212					440K-T11367	—			
Guide/fully flexible	440K-T11338	440K-T11213					440K-T11368	—			
—	440K-T11147	—					440K-T11226	—			
MBB	GD2 standard	440K-T11339				440K-T11470	440K-T11369	—			
	Guide/semi-flexible	440K-T11340				440K-T11471	440K-T11370	—			
	Guide/fully flexible	440K-T11341				440K-T11472	440K-T11371	—			
	—	440K-T11167				—	440K-T11372	—			
Trojan 5 30 N						BBM	Standard	440K-T11333	440K-T91024	440K-T11492	—

♣ For connector ratings see Safety Switches and Connectors.

Δ With a 5-pin micro (M12) connector, not all contacts are connected. See Typical Wiring Diagrams for wiring details.

Type	Contact			Actuator Type	Cat. No.		
					M20 Conduit		Connector♣
	Safety	Auxiliary	Action		M20	1/2 inch NPT Adaptor	8-Pin Micro (M12)Δ
Trojan 6	3 N.C.	1 N.O.	BBM	Standard	440K-T11171	440K-T11435	—
				—	440K-T11449	440K-T11408	—
	2 N.C.	2 N.O.	BBM	Standard	440K-T11174	440K-T11438	—
				—	440K-T11452	440K-T11416	440K-W21BNPH
		MBB	—	440K-T11453	440K-T11454	440K-W21MNPH	
Trojan 6 GD2	3 N.C.	1 N.O.	BBM	GD2 Standard	440K-T11418	440K-T11466	—
				—	440K-T11188	440K-T11444	—
			MBB	—	440K-T11456	440K-T11457	—
	2 N.C.	2 N.O.	BBM	GD2 Standard	440K-T11445	440K-T11425	—
				—	440K-T11459	440K-T11433	440K-W21BNPH-NG
			MBB	—	440K-T11460	440K-T11461	440K-W21MNPH-NG

♣ For connector ratings see Safety Switches and Connectors.

Δ With an 8-pin micro (M12) connector, not all contacts are connected. See Typical Wiring Diagrams for wiring details.

## Recommended Logic Interfaces

Description	Safety Outputs	Auxiliary Outputs	Terminals	Reset Type	Power Supply	Cat. Page No.	Cat. No.
<b>Single-Function Safety Relays</b>							
MSR127RP	3 N.O.	1 N.C.	Removable (Screw)	Monitored Manual	24V AC/DC	MSR127RP/TP	440R-N23135
MSR127TP	3 N.O.	1 N.C.	Removable (Screw)	Auto./Manual	24V AC/DC	MSR127RP/TP	440R-N23132
MSR126T	2 N.O.	None	Fixed	Auto./Manual	24V AC/DC	MSR126R/T	440R-N23117
MSR30RT	2 N.O. Solid State	1 N.O. Solid State	Removable	Auto./Manual or Monitored Manual	24V DC	MSR30RT/RTP	440R-N23198
<b>Modular Safety Relays</b>							
MSR210P Base 2 N.C. only	2 N.O.	1 N.C. and 2 PNP Solid State	Removable	Auto./Manual or Monitored Manual	24V DC from the base unit	MSR210P	440R-H23176
MSR220P Input Module	—	—	Removable	—	24V DC	MSR220P	440R-H23178
MSR310P Base	MSR300 Series Output Modules	3 PNP Solid State	Removable	Auto./Manual Monitored Manual	24V DC	MSR310P	440R-W23219
MSR320P Input Module	—	2 PNP Solid State	Removable	—	24V DC from the base unit	MSR320P	440R-W23218

**Note:** For additional Safety Relays connectivity, see Safety Relays.  
For additional Safety I/O and Safety PLC connectivity, see Programmable Safety Solutions.  
For application and wiring diagrams, see Safety Applications and Wiring Diagrams.









## Connection Systems

Description	Trojan 5		Trojan 6
	5-Pin Micro (M12)	6-Pin Micro (M12)	8-Pin Micro (M12)
Cordset	—	889R-F6ECA-*	889D-F8AB-*
Patchcord	889D-F5ACDM-*	889R-F6ECRM-‡	889D-F8ABDM-‡
Distribution Box	—	898R-F68MT-A5	—
Shorting Plug	—	898R-P61MU-RM	—
T-Port	—	—	—

\* Replace symbol with 2 (2 m), 5 (5 m), or 10 (10 m) for standard cable lengths.  
‡ Replace symbol with 1 (1 m), 2 (2 m), 3 (3 m), 5 (5 m), or 10 (10 m) for standard cable lengths.  
§ Replace symbol with 4 or 8 for number of ports.

**Note:** For additional information, see Safety Connection Systems.

## Accessories

Description	To Be Used With:	Dimensions	Cat. No.
 Standard actuator	Trojan 5 and Trojan 6. Not to be used with GD2 models.	Actuators*	440K-A11095
 GD2 standard actuator	GD2 models only.		440G-A27011
 GD2 flat actuator	GD2 models only.		440K-A11112
 Alignment guide with semi-flexible actuator	Discard alignment guide for GD2 models		440K-A11144
 Alignment guide with fully flexible actuator	Discard alignment guide for GD2 models		440K-A27010
 Sliding bolt actuator	GD2 models only.	Door Handles	440G-A27163
 Catch and Retainer Kit	Trojan 5 and Trojan 6. Not to be used with GD2 models.	Actuators*	440K-A11094
 Replacement Cover	Trojan T5 standard model only.	—	440A-A11495
	Trojan T5 GD2		440A-A11496
	Trojan T6 standard model only.		440A-A11497
	Trojan T6 GD2		440A-A11498
 Dust Cover	All models.	—	440K-A17180

### Approximate Dimensions

Dimensions are shown in mm (in.). Dimensions are not intended to be used for installation purposes.

**Standard Model**

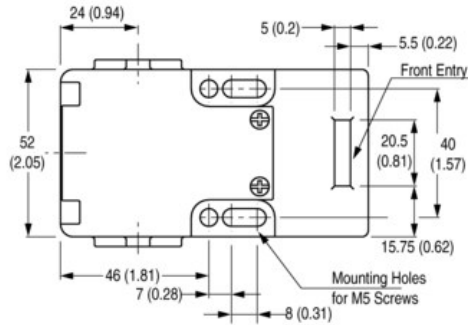
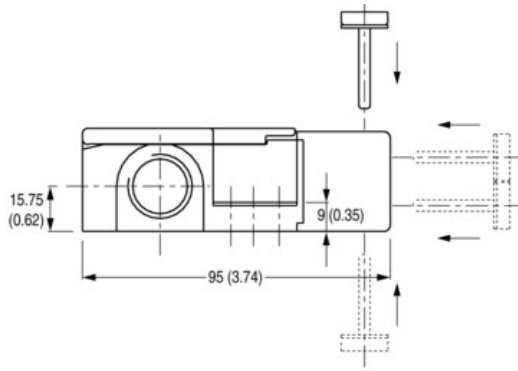
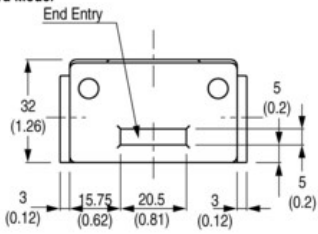



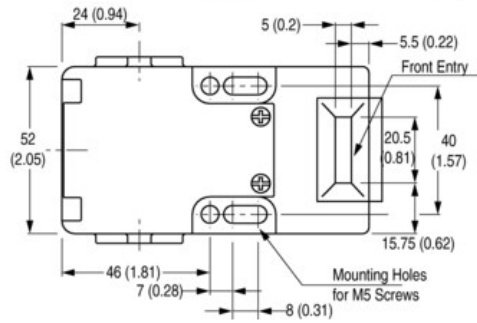
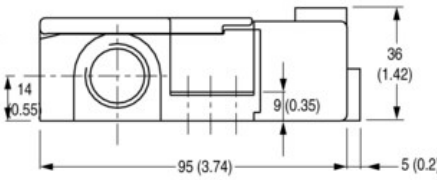
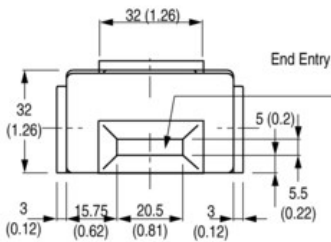

**GD2 Model**

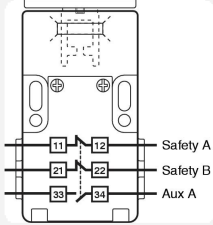
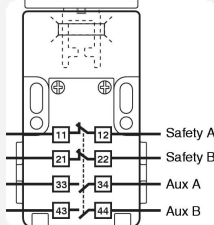
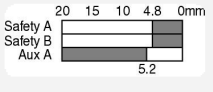

Note: 2D, 3D and electrical drawings are available on [www.ab.com](http://www.ab.com).

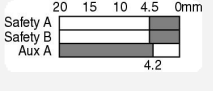
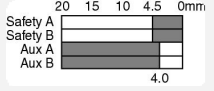
**Typical Wiring Diagrams**

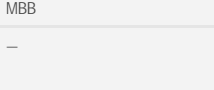
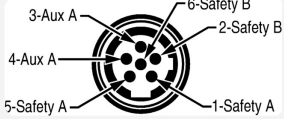
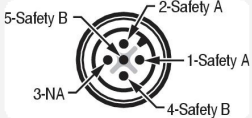
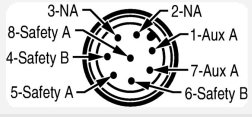
Description	Trojan 5		Trojan 6	
	2 N.C. & 1 N.O.		2 N.C. & 2 N.O.	3 N.C. & 1 N.O.
Contact Configuration				
Contact Action				
□ Open ■ Closed	BBM 		BBM 	
	MBB 		MBB 	
6-Pin Micro (M12)			-	
5-Pin Micro (M12) for ArmorBlock Guard I/O			-	
8-Pin Micro (M12)	-			
6-Pin Cordset 889R-F6ECA-*	Red/White	Safety A	-	
	Red/Black		-	
	Red	Safety B	-	
	Red/Blue		-	
	Green	Aux	-	
	Red/Yellow		-	
8-Pin Cordset 889D-F8AB-*	Grey Red	-	Safety A	-
	Yellow Pink	-	Safety B	-
	White Blue	-	Aux A	-
	Green Brown	-	NA	-

\* Replace symbol with 2 (2 m), 5 (5 m) or 10 (10 m) for standard cable lengths.